

MaxMotion

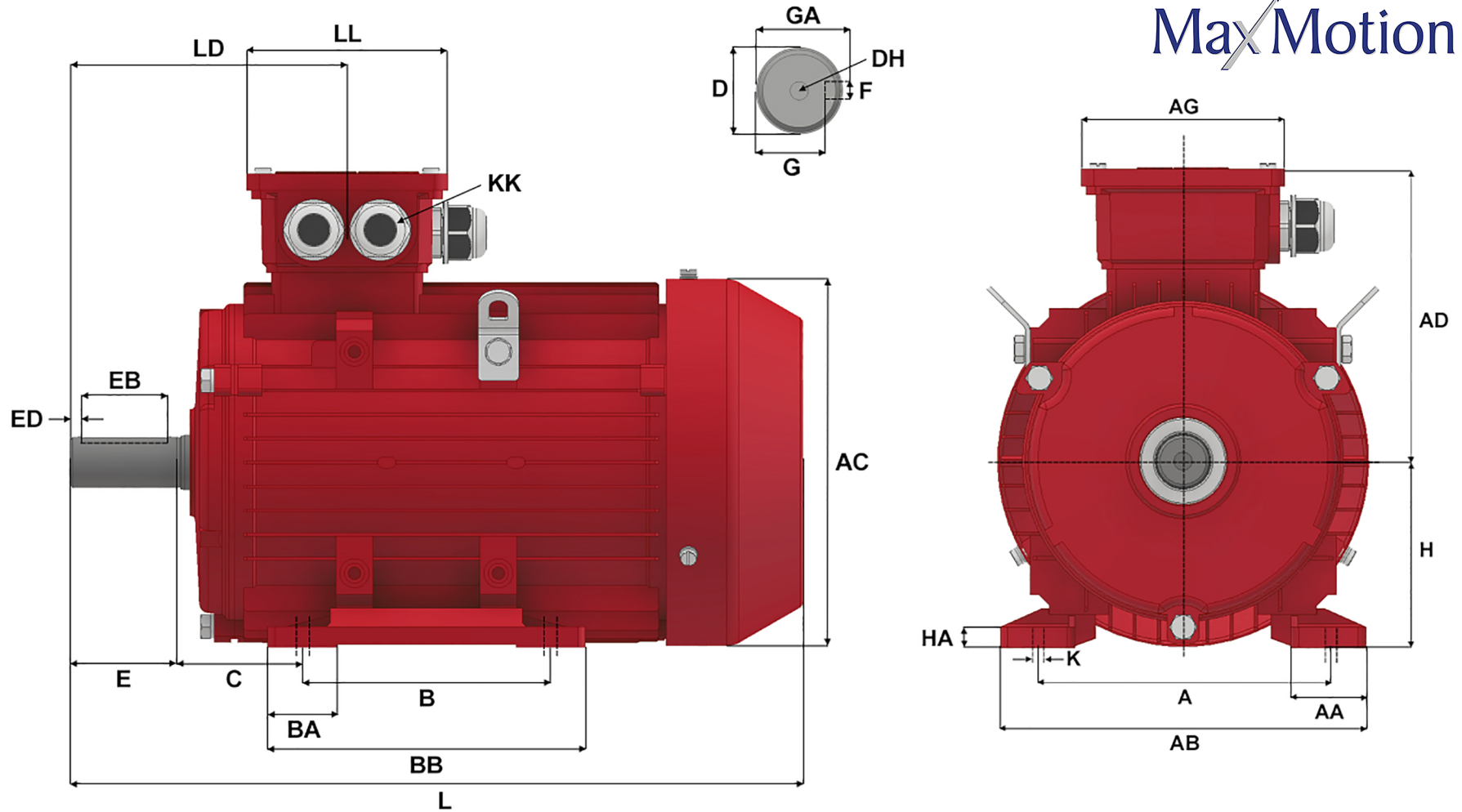

Version: 1JLEM		Revised: 09-11-2019		HP	RPM	FRAME	ENCLOSURE	IJA160L-6-B3								
Customer is responsible in determining that Max Motion product will fit/perform suitably in the intended application								15	1165	160L	TEFC					
A	B	C	D	E	F	G	H	K	L	AA	AB	AC				
254	254	108	42	110	12	37	160	15 X 18	660	55	304	315				
AD	AG	BA	BB	DH	EB	ED	GA	HA	KK (1)	KK (2)	KK (3)	LD				
242	160.5	50	304	M16 X 36	90	10	45	18	M40 X 1.5	1" NPT	M16 X 1.5	268.5				
LL																
155																